

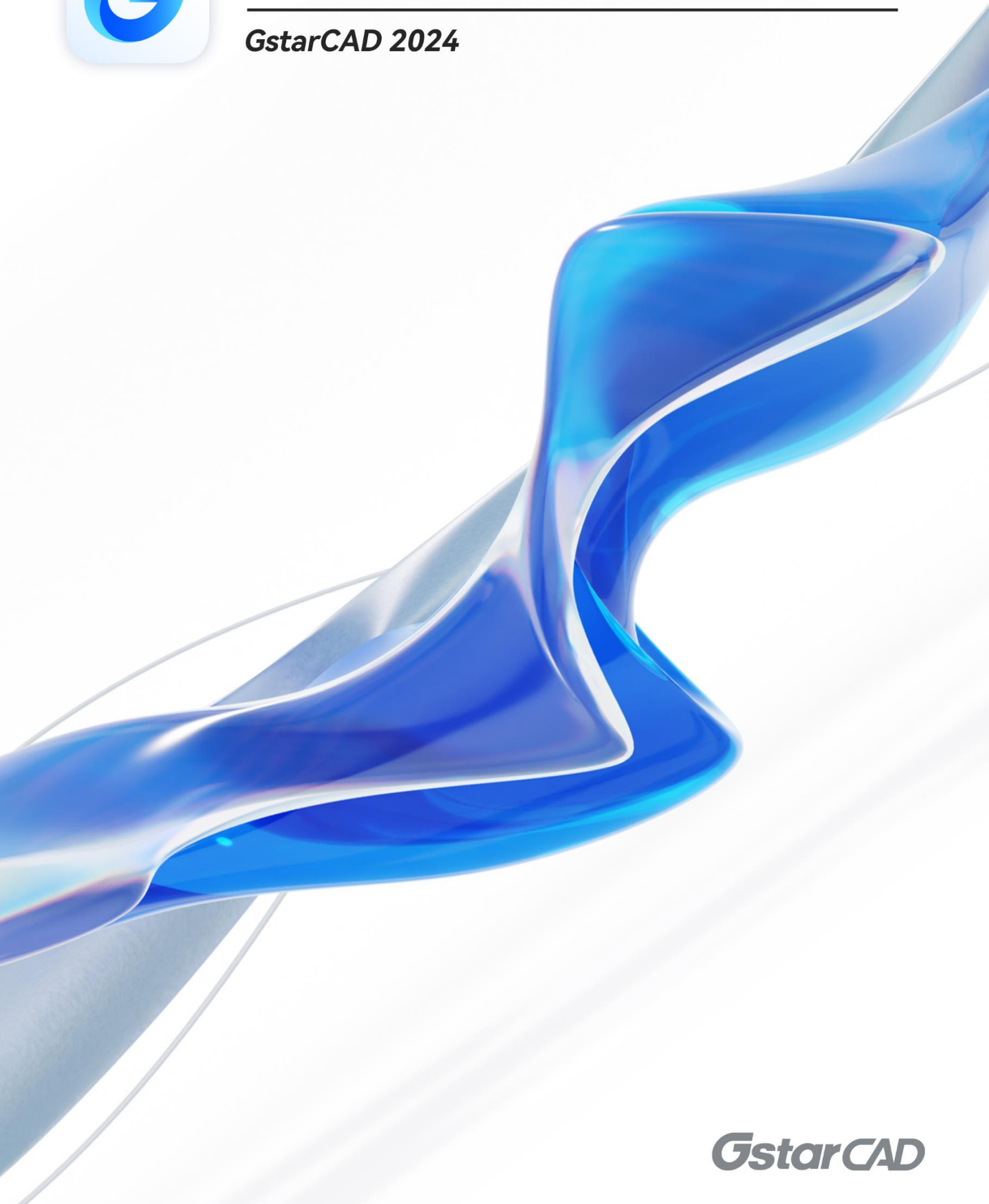

Complete Features Guide

GstarCAD 2024



GstarCAD 2024 Content

1. Excellent Performance.....	3
2. Perfect Compatibility.....	4
3. Flexible Licensing.....	7
3.1. Licensing Policy.....	7
3.2. Licensing Options.....	8
4. Innovative Features.....	8
5. What's New in GstarCAD 2024.....	10
5.1. Performance <i>Improvement</i>	10
5.1.1. Loading performance and display optimization of large raster images.....	10
5.1.2. Hatch Quick Preview.....	11
5.1.3. Lineweight Display Optimization.....	12
5.2. API <i>Improvement</i>	12
5.2.1. LISP.....	12
5.2.2. .NET.....	14
5.3. Dynamic Input <i>Improvement</i>	15
5.3.1. Independent Pointer Input Boxes.....	15
5.3.2. Vertical Dynamic Prompts List.....	17
5.3.3. Dynamic Dimension Input.....	18
5.4. BIM Support <i>New</i>	21
5.5. STEP/IGES Files Import <i>New</i>	25
5.6. Viewports Edit <i>New</i>	25
5.7. VPMAX/VPMIN <i>New</i>	27
5.7.1. VPMAX.....	27
5.7.2. VPMIN.....	28
5.8. DWFX Batch Digital Signing Tool <i>New</i>	28



GstarCAD 2024 Complete Guide

Seamless Experience with High Compatibility

With accelerated performance, enhanced compatibility and elevated user experience, GstarCAD 2024 takes design productivity to new heights. Experience optimized speed and quality when working with large files, enjoy expanded compatibility with support for more file formats and APIs, and discover a new level of design satisfaction with the upgraded Dynamic Input tool and adjustable viewports, etc. Join us and take a look at the exciting features of GstarCAD 2024!

1. Excellent Performance

Higher performance plays an important role in GstarCAD. GstarCAD not only constantly provides users with more useful functions, but also delivers great performance in both 2D and 3D operations.

The performance of commonly-used operations like "OPEN", "QSAVE", "PLOT", "CLIP", "TRIM", "PASTE", "MOVE", "DYNAMIC SELECTION", and more commands are significantly faster than other CAD software. Large drawings could be opened more quickly and your work can be saved in only a fraction of a second.

The chart below provides an overview of the performance of GstarCAD 2024. We built an operation speed comparison of the basic features between GstarCAD and other CADs. Two drawings were used to test the operation time, one was around 48 MB and another was around 114 MB. To make sure the data validation, the same operations were tested twice and got the average value.

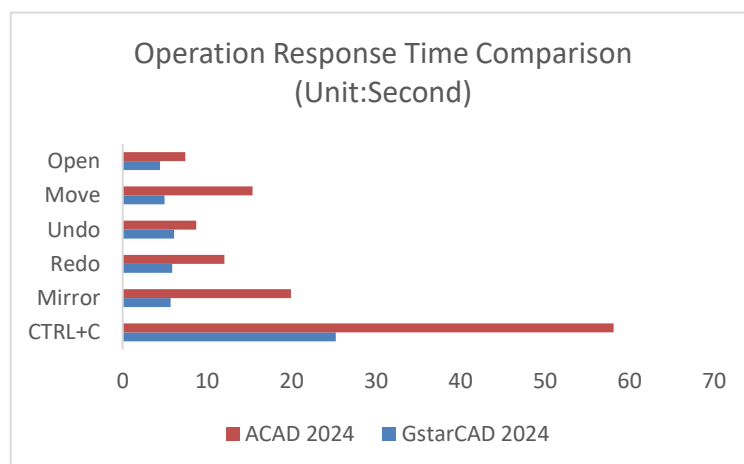

Testing Environment: WIN11 64bit; 16G storage; CPU: Intel i7-1165G7

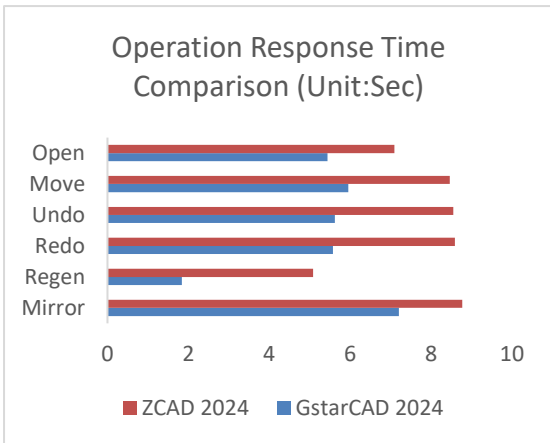

Testing Environment: WIN10 64bit; 16G storage; CPU: Intel i5-10400

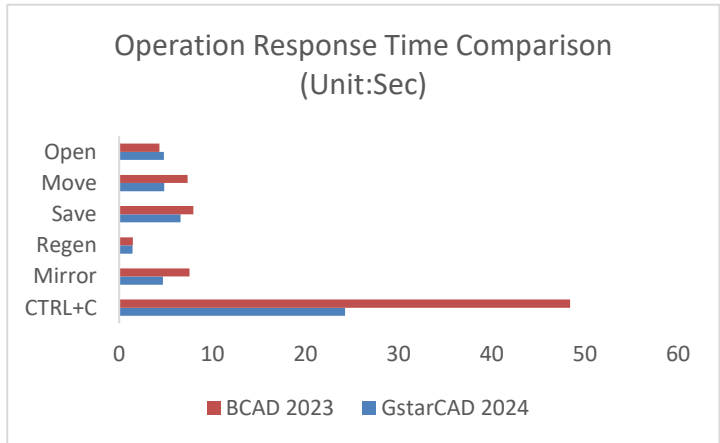

Testing Environment: WIN11 64bit; 16G storage; CPU: Intel i5-11400

It's obvious that GstarCAD 2024 is faster than other CAD software when executing OPEN, MOVE, UNDO, REDO, MIRROR, REGEN, SAVEAS and CTRL+C commands. And it is extremely good when executing COPY TO CLIPBOARD command. Besides the chart, GstarCAD also works excellently in ARRAY and EXPLODE commands, while the other CADs couldn't even array objects in the same drawing. Additionally, executing EXPLODE with the other CAD software wouldn't get a response for a long time. Compared with other CAD software, GstarCAD is far ahead in performance, especially when it comes to large drawings.

2. Perfect Compatibility

GstarCAD delivers high compatibility with ACAD and provides robust APIs. The seamless data format, familiar interface, command structure and user operating habit ensure an easy transition, while the powerful APIs allow for extensive customization and automation, empowering you to tailor the software to your specific needs.

➤ Data Format

GstarCAD 2024 supports the native DWG/DXF file formats which are completely compatible with ACAD from version 2.5 to 2024. Any CAD drawings based on the DWG/DXF format can be easily processed by GstarCAD. Meanwhile, the drawings created by GstarCAD also can be processed by other CAD software. GstarCAD 2024 fully realizes bidirectional compatibility with ACAD in data formats.

Furthermore, GstarCAD 2024 even supports various kinds of data file formats and application development interfaces. You could create or edit drawings in completely original ways.

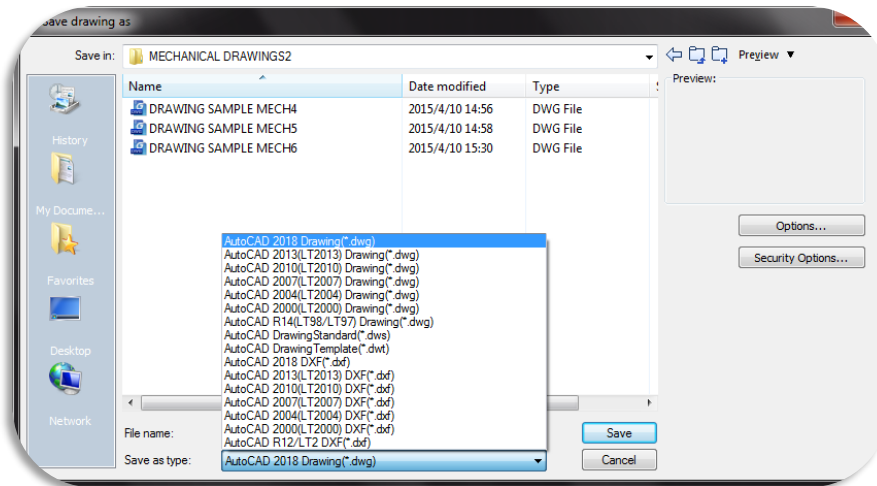

The main file formats and development interfaces between GstarCAD and ACAD.

Items	GstarCAD	ACAD
2.5-2018 DWG/DXF Versions	✓	✓
Drawing Template File (DWT)	✓	✓
Drawing standard File (DWS)	✓	✓
Customize User interface file (CUI/CUIX)	✓	✓
Old Menu File (MNU)	✓	✓
Drawing Sheet Set File (DST)	✓	✓
Hatch Pattern File (PAT)	✓	✓
Font File (SHX)	✓	✓
Line Type File (LIN)	✓	✓
Print Style File (CTB/STB)	✓	✓
Import and Export WMF	✓	✓
Import and Export SAT	✓	✓
Import 3DS	✓	✓
Import DGN	✓	✓
Export DWF/DWFX	✓	✓
Export STL	✓	✓
Export EMF	✓	✓
DWF Underlay	✓	✓
PDF Underlay	✓	✓
DGN Underlay	✓	✓
Script File (SCR)	✓	✓
LISP Development Interface	✓	✓
LSP File Loading	✓	✓
FAS File Loading	✓	✓
VLX File Loading	✓	✓

VBA Development Interface	✓	✓
Class ARX Development Interface	✓	✓
.net Development Interface	✓	✓

➤ **Concise User Interface**

GstarCAD 2024 offers you a concise and familiar interface. The combination of attractive dark color theme and icon designs helps reduce your eyestrain. It's also available for you to display and rearrange elements like the toolbars, display the command bar, switch between workspaces, change the interface themes, customize your own interface and enable the status bar. The toolbars and command bar can also be floated anywhere on the screen or docked as well.

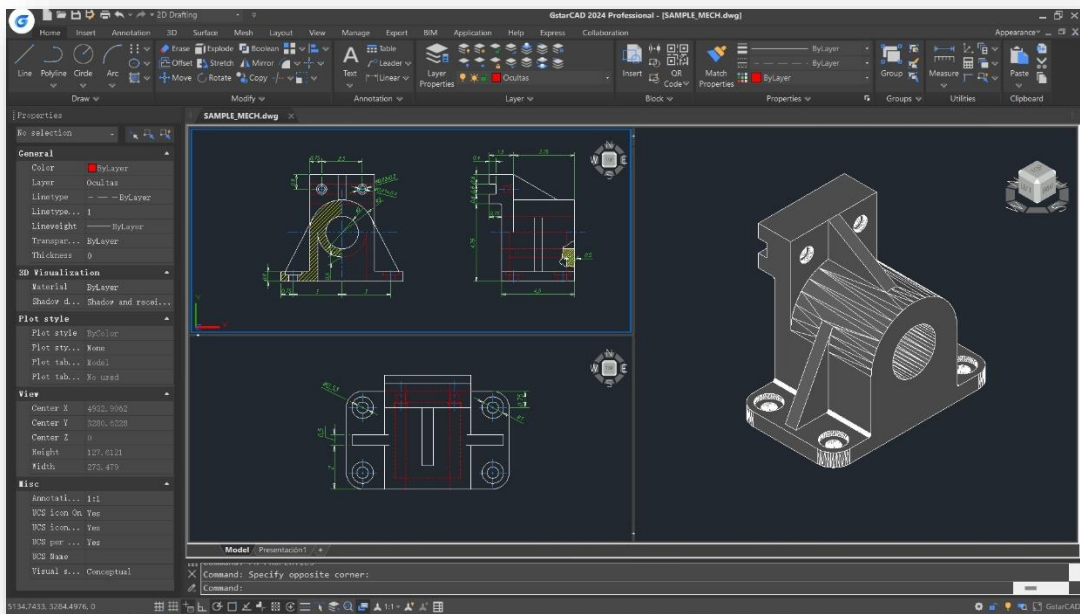

➤ **Familiar Command**

You can get started with GstarCAD immediately with the familiar command structure and shortcut system that you have known without extra learning. Whether you're a novice user or an experienced CAD professional, you can quickly start creating drawings using the productivity-enhancing features of GstarCAD.

GstarCAD Commands	ACAD Commands	GstarCAD Commands	ACAD Commands
Multiple	Multiple	Superhatch	Superhatch
Osnap	Osnap	Redraw	Redraw
Qselect	Qselect	Regen	Regen
Qleader	Qleader	Scalelistedit	Scalelistedit
Spell	Spell	Bedit	Bedit

Layerp	Layerp	Render	Render
Layoff	Layoff	Flatshot	Flatshot
		

➤ **Customized Settings**

GstarCAD offers several methods to import your customized settings such as CUI, Lisp program, Shortcut settings, Blocks, DWT, Tool palettes, Plotters and more from other CAD software. In just a few minutes, you can recreate the interface that you're familiar with in GstarCAD.

➤ **API and Add-ons**

GstarCAD offers friendly development interfaces such as GRX, .NET, VBA, Lisp, COM, etc. Nowadays, hundreds of professional applications and industrial solutions are running on GstarCAD.

For more information about applications/add-ons of GstarCAD, please refer to the link:

<https://www.gstarcad.net/application/>

3. Flexible Licensing

3.1. Licensing Policy

GstarCAD's licensing policy is flexible and simple. We provide both perpetual license and subscription. You are free to choose the license mode and you decide when to upgrade.

- **Perpetual License**

When you choose to buy GstarCAD Perpetual License, you have the right to use it perpetually. Buy it once and it's forever yours. You are not forced to buy the subscription or upgrades.

- **Perpetual License and Subscription Plans**

You can buy GstarCAD Perpetual License together with Subscription Plans. Gstarsoft releases a new GstarCAD major version every year, with Subscription Plans you can upgrade to the latest version of GstarCAD.

- **Yearly Subscription**

GstarCAD Yearly Subscription is similar to ACAD Subscription; you can just pay a smaller amount for GstarCAD's 1-year license.

- **GstarCAD Upgrades**

Gstarsoft releases a new GstarCAD major version every year; you can upgrade your GstarCAD Perpetual License to the Perpetual License of any newer version!

3.2. Licensing Options

GstarCAD not only provides a flexible licensing policy, but also provides flexible licensing Options. GstarCAD offers Stand-alone and Network licenses, both are available with Soft key (Serial number) and Dongle (USB-key).

- **Stand-alone license**

The software is constrained to a certain host. A license is needed for each computer on which the software will be installed.

- **Network license**

A pool of licenses is available on the server, for users of any computers on the network. You only need to have licenses for the maximum number of simultaneous users expected, not for each computer where the software will be installed.

	Stand-alone		Network	
	License-key Serial number	USB-key Dongle	License-key Serial number	USB-key Dongle
Perpetual license	✓	✓	✓	✓
Rental license	✓	×	✓	×
License borrowing	×	×	✓	×
Connection to license server	×	×	✓	✓

4. Innovative Features

GstarCAD offers over 100 unique and innovative tools like "Collaboration", "Area Table", "Auto Layer", "Viewport to Layout", and "AutoxIstable". They are adopted to significantly speed up your drafting speed.

GstarCAD Innovative Features	Description
Autolayer	Automatically switch the current layer while drawing the graph and draws the graphic to the set layer.
Area Table	Automatically dimension and count the area of an enclosed object and export the result to a table in the current drawing area.
Break Object	Breaks Objects by intersecting lines and allows to set the gap.

Block Break	Breaks or shelters the graphic under the block.
Graphic Compare	Compares graphic of two groups of objects or two files.
Line2pl	Converts one or multiple connected straight line(s), arc(s) to one polyline.
Sptpl	The spline created can be converted to a polyline according to the accuracy (number of segments of the arc).
GstarCAD Tools	A set of GstarCAD practical tools to enhance design efficiency, Including Drawing Scale, Rotate Cursor, Draw Axonometric Line, Extension, Normal Connect, etc.
Drawing Lock	Turns the drawing into a whole block to prevent being modified by others.
Attribute Increment	Specifies attribute of blocks with incremental value, and modifies attribute value of blocks according to the sort method.
Define Layout Viewport from Model Space (M2LVPORT)	Defines the range of drawing displayed in the viewport from the model space, calculates the viewport size based on the set scale and positions the viewport in the layout space.
Align Tool	Aligns selected objects such as rectangle, circle, line, spline, arc, pline, block and even 3D model object along X or Y axis coordinates.
Arrange Tool	Adjusts the arrangement of multiple objects. It can align multiple objects at left, right, top, bottom and center and also can arrange vertically or laterally.
MEASUREGEOM	Supports measuring distance, radius, angle, area, volume sum area and so on.
Symmetric Draw	Generates the symmetrical object automatically when drawing an object.
Outline Objects	Extracts the outline shape of selected closed objects in a window selection method.
Invert Fillet	The FILLET command now offers a new option called Invert. You can create a reverse fillet with this option.
Magnifier	Views a specific area of your drawing as a magnifier with the capability of snap points without performing zoom in/out.
Barcode & QR Code	Creates Barcode & QR Code by entering data or picking data from drawings.
Shortcut Customization(CUSTACC)	The CUSTACC command allows you to customize, delete or modify existing command shortcuts.
Table Tools	A set of practical tools to draw and edit tables and can export CAD tables to Excel files.
AutoXLSTable	Opens Excel file to edit the data and insert it into GstarCAD. It also allows updating the table data after the drawing was modified.
Pline Boolean	Supports different Boolean operation options such as union, intersection and subtraction.
Batch Print	Batch print drawings with the same drawing frame attribute in a drawing.
Arrange Frame	Inserts frames of drawings, calculates according to the size of the frame and then arranges them to a big drawing.
GstarCAD Collaboration	Helps to improve project design efficiency and significantly reduce error and cost.
...	...

5. What's New in GstarCAD 2024

5.1. Performance *Improvement*

The stability and performance have been significantly improved in GstarCAD 2024, enhancing your design workflow.

5.1.1. Loading performance and display optimization of large raster images

When using OPEN, IMAGEATTACH, and other commands to open or load a drawing with a large raster image, GstarCAD 2024 will quickly open the preview image at a low resolution or provide image properties. After the image parsing is completed, it'll seamlessly replace the preview image with the original high-resolution drawing.

This improvement solves the problem of long response time when opening or attaching drawings with large raster images.

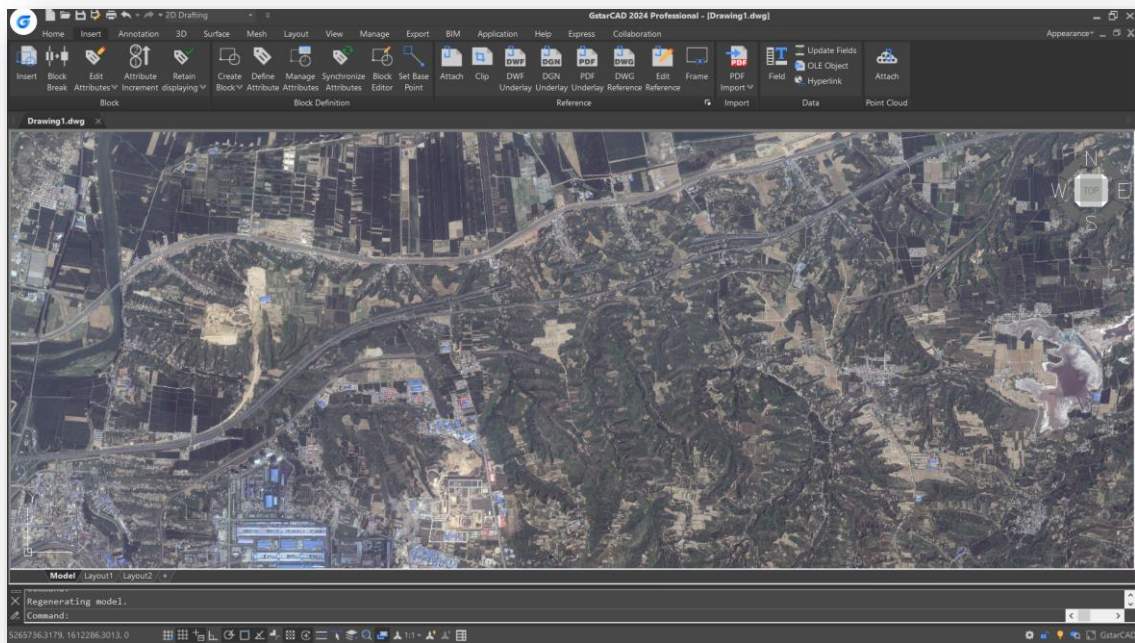

Note: Systems below WIN7 do not support this enhancement.

5.1.2. Hatch Quick Preview

In GstaCAD 2024, hatch preview remains quick and real-time even in complex drawings.

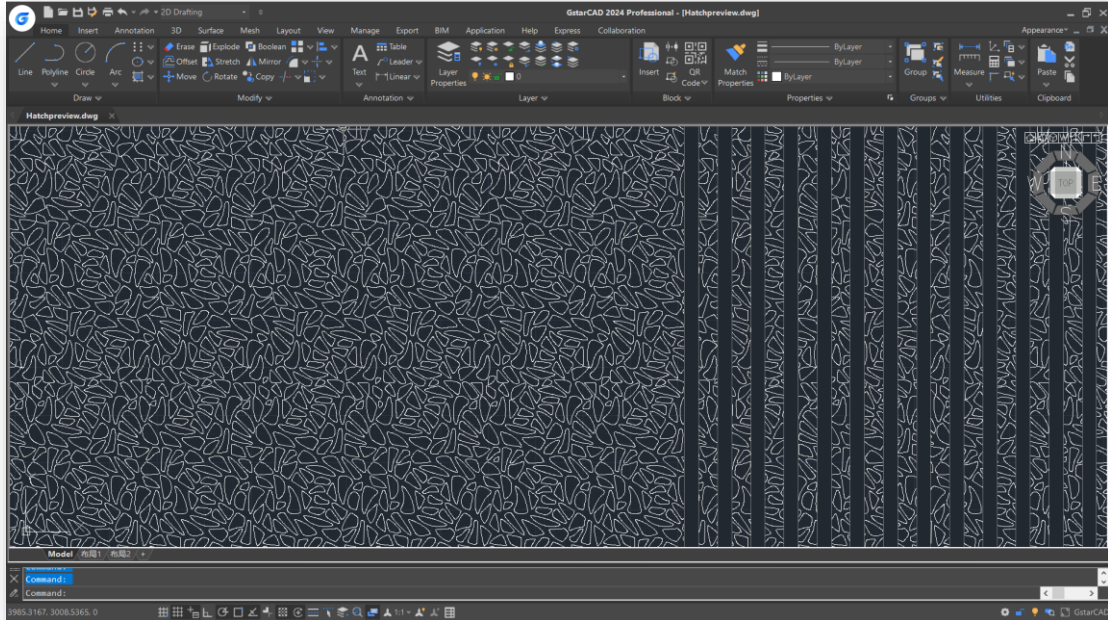

Note: When the drawing is zoomed to a rather small size, some areas that could have been filled with hatch preview may not be able to display the hatch preview due to pixel squeeze.

System Variable	Description	Value	Value Description
HATCHQUICKPREVIEW	Controls whether to display hatch preview when there're a large number of hatch entities	0	Entity Number ≤ 3000 , hatch preview on Entity Number > 3000 , hatch preview off
		-3000~3000 (Except 0)	n > 0, hatch preview on: Entity Number $\geq n$, hatch preview on Entity Number $< n$, process it as if the value = 0 n ≤ 0 , hatch preview off: process it as if the value = 0, the negative value will be stored

5.1.3. Lineweight Display Optimization

Lineweight display is optimized with better transparency, and when there're many lines with set lineweight in the drawing, the display performance has also been improved.

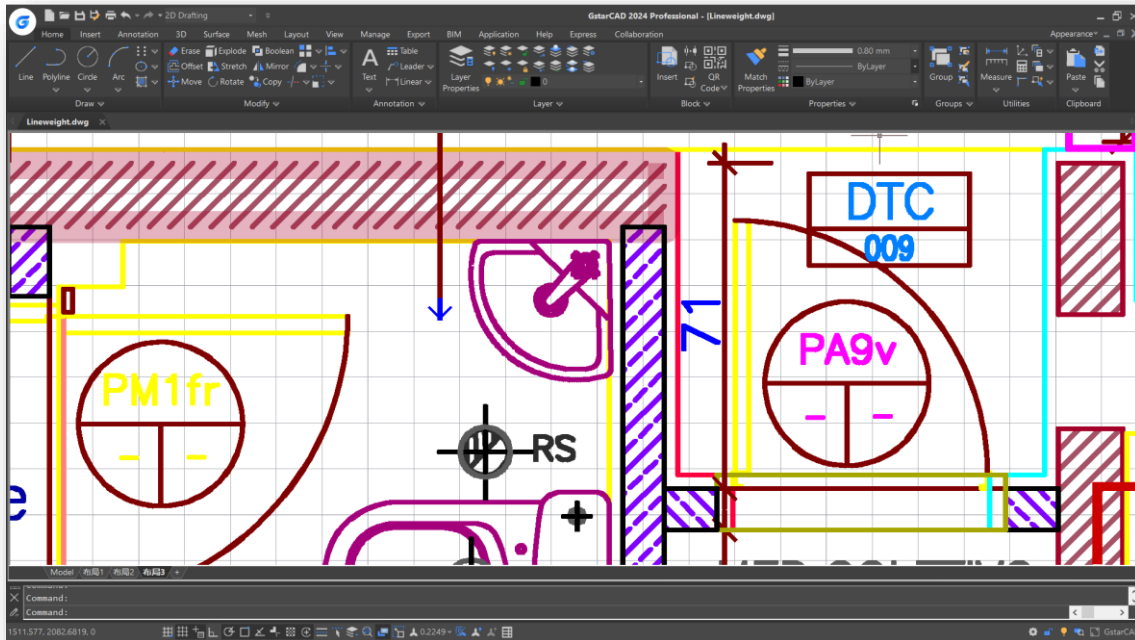

System Variable	Description	Value	Value Description
LWEIGHTDRAWCTRL	Controls whether turn on transparency display for lines with set lineweight	0	Off
		1	On

5.2. API [Improvement](#)

GstarCAD offers robust APIs for developers to migrate or build applications on GstarCAD, including GRX, .NET, VBA, LISP, and COM. In GstarCAD 2024, .NET and LISP have been greatly optimized.

5.2.1. LISP

- The compatibility of the LISP engine with Unicode encoding has been improved, supporting the use of different encoding formats such as UTF-8 and UTF-16 for writing LISP programs. This enhancement resolves the issue of loading failure caused by strings containing multiple languages;

- The compatibility of the Dialog Control Language (DCL) with Unicode encoding has also been improved, resolving the issue of software stuck caused by failed dialog calls. Additionally, we fixed errors caused by the lack of Chinese support in DCL code, ensuring the accurate display of interfaces in different languages;
- Supports the FAS5 protocol type in LISP binary compiled files, and supports the parsing of Unicode characters in file paths and file names, which improves the compatibility of FAS files with Unicode;
- Perfectly compatible with general LISP interfaces, such as data reading and writing, string processing, object processing, file loading and parsing, etc., which improves operating efficiency;
- Added ACET extension interfaces to 411, and encapsulated frequently-used operations and functions. Users can call ACET interfaces to realize complex functions;
- Adds LISPSYS system variable, which supports switching between using ASCII (MBCS) or Unicode character sets when saving or compiling LSP files, simply by changing the value of the variable, so as to meet different LSP file compilation requirements;
- Adapts to drawing plug-ins such as Yanxiu Toolbox perfectly, which supports more than 200 commands, enhancing the extensibility of LISP.

System Variable	Description	Value	Value Description
LISPSYS	Controls the default GLISP development environment and editor which are started by executing the VLISP command.	0	<p>1. Visual Studio (VS) Code is set as the default editor, and GstarLisp function does not fully supports Unicode characters.</p> <p>2. GstarLisp source (LSP) files use ASCII (MBCS) character set when saving and compiling.</p> <p>Note: This setting takes effect in GCAD 2024, and the VLIDE editor is opened by default.</p>
		1	<p>1. Visual Studio (VS) Code is set as the default editor, and GstarLisp function fully supports Unicode character set.</p> <p>2. The GstarLisp source (LSP) files use the encoding set in VS Code when saving, and use the Unicode character set when compiling.</p>

1. Visual Studio (VS) Code is set as the default editor, and GstarLisp function fully supports Unicode characters.

2. The GstarLisp source (LSP) files use the encoding set in VS Code, and use the ASCII (MBCS) character set when compiling.

Note: After changing the value of the LISPSYS system variable, you need to restart GstarCAD to change the GstarLisp development environment.

5.2.2. .NET

Built on advanced C++/CLI technology, .NET secondary development interface offers a reliable platform for developers. With 100% integrity in core module interfaces that are most commonly used, GstarCAD 2024 ensures efficient development and seamless cross-platform compatibility.



- The .NET secondary development interface structure has been adjusted, GcCoreMgd.dll, GcDbMgd.dll, GcMgd.dll and other core modules are now consistent with ACAD while maintaining the integrity of existing functions, which further improves the efficiency of .NET development and transplantation;
- Added over 400 interfaces, including core interfaces in classes like NurbSurface, TransientManager, and Curve.
- Added B-Rep (Boundary representation) .NET development module GcDbMgdBrep.dll, which provides a .NET secondary development interface for boundary representation;
- Refactored ResultBuffer and related classes to provide better support for the storage of basic CAD data classes, and the functions are completely consistent with ACAD.

5.3. Dynamic Input *Improvement*

In GstarCAD 2024, the Dynamic Input system has been upgraded. With new functions of Dimension Input, vertical Dynamic Prompts list and independent Pointer Input boxes, now it provides an easier-to-use experience and improves design efficiency.

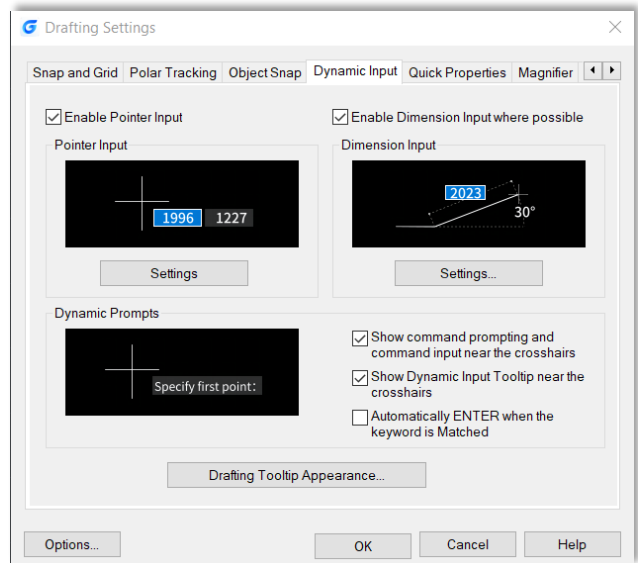

5.3.1. Independent Pointer Input Boxes

Pointer Input boxes for length, angle and coordinates, etc. are now displayed independently, making it more convenient for users to input different values by simply switching between the boxes using the TAB key.

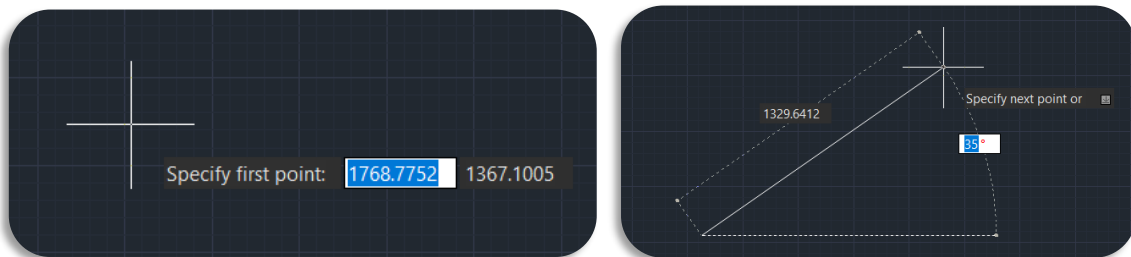

Auxiliary Keys:

- **TAB key:** Press the TAB key to switch between input boxes. After changing the value in an input box and pressing the TAB key to switch to the next input box, a yellow lock will appear in the previous input box, indicating that the value has been edited and locked. It will unlock automatically when switching to this box again using the TAB key.
- **“ , ”:**
 - After inputting the value, you can lock the current input box and switch to the next input box by pressing “ , ” on the keyboard.
 - After inputting the value of X and Y coordinates, press “ , ” key and the input box for Z coordinate will show.
 - In the length input box, press “ , ” key after entering the length value to switch to coordinates.
 - In the angle input box, press “ , ” key after entering the angle value to switch to coordinates.
- **“ * ”:** Before entering the coordinates, press “ * ” to display all the input boxes for X, Y and Z coordinates at once.

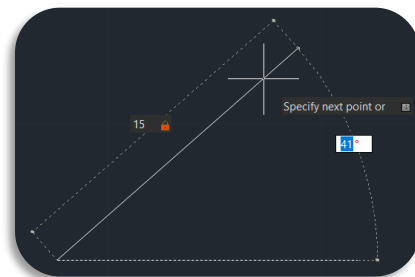

- “<”: Entering "<" after inputting the value in a coordinate input box, the second input box will switch to an angle input box.

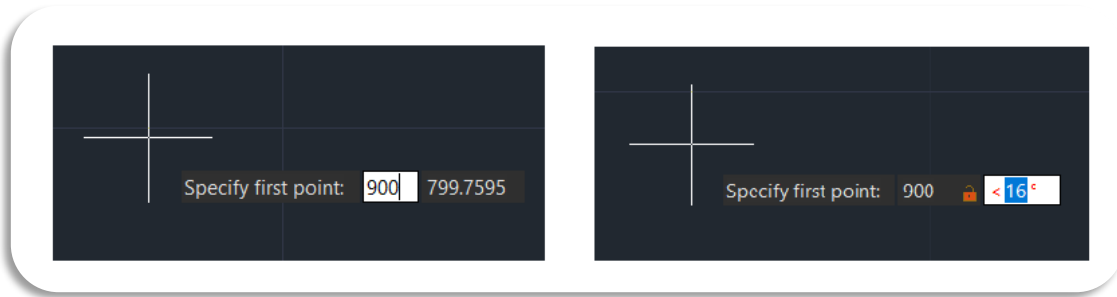

- “@”: Before entering coordinates, enter “@” to input relative coordinates.
- “#”: Before entering coordinates, enter “#” to input absolute coordinates.
- **Up key**: Press the Up key on the keyboard to check the input point history.
- **Down key**: Press the Down key to display the command prompts list.
- **Shift + Right Click**: Right-click menu pops up.
- **ESC key**: Exit pointer input.

Pointer Input Box Types:

- Contains command prompting, no or only one input box
- Contains command prompting, with one input box and a command prompts list
- Contains command prompting and two input boxes
- Contains command prompting, two input boxes and a command prompts list

Note: In this case, you can enter the command shortcut key in the input box to quickly locate it in the prompts list.

- Contains command prompting and three input boxes (displaying XYZ coordinates, absolute coordinates or relative coordinates)
- Contains command prompting and four input boxes (displaying XYZ values in absolute coordinates or relative coordinates)
- Contains command prompting, dimension lines and corresponding input boxes

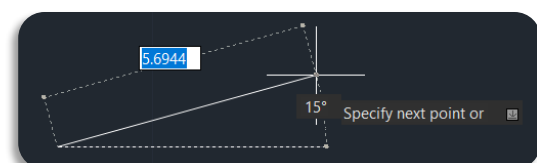
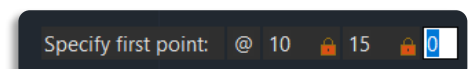
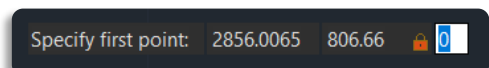
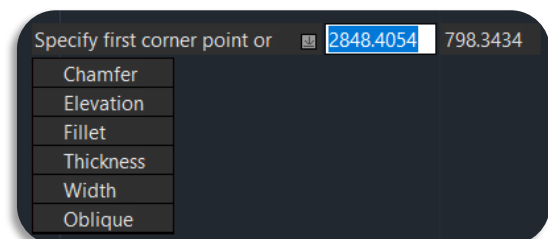
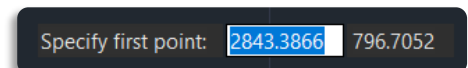
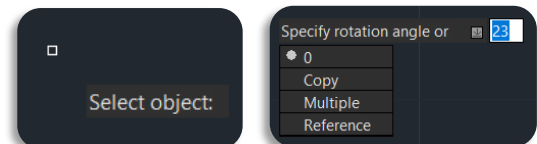

Pointer Input Setting:

You can go to Drafting Settings (DSETTINGS command) ➤ Dynamic Input ➤ Pointer Input ➤ Settings to open the Pointer Input Settings dialog box.

- **Polar format:** Displays a tooltip for the second or the next point in polar format. Enter "," to switch to Cartesian format. (DYNPIFORMAT System Variable)
- **Cartesian format:** Displays a tooltip for the second or the next point in Cartesian format. Enter "<" to switch to polar format. (DYNPIFORMAT System Variable)
- **Relative coordinates:** Displays a tooltip for the second or the next point in relative coordinate format. Enter "#" to switch to absolute coordinate format. (DYNPICOORDS System Variable)
- **Absolute coordinates:** Displays a tooltip for the second or the next point in absolute coordinate format. Enter "@" to switch to relative coordinate format. (DYNPICOORDS System Variable)

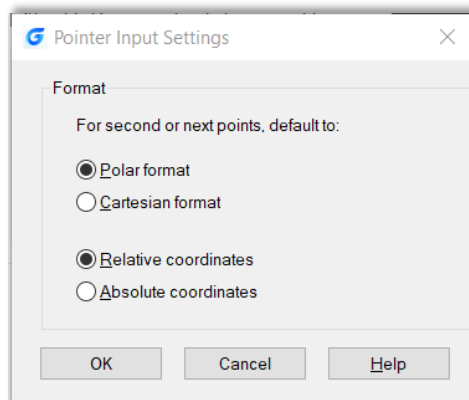

System Variable	Description	Value	Value Description
DYNPIFORMAT	Controls whether pointer input uses polar or Cartesian format for coordinates. This setting takes effect for the second or next point.	0	Polar format
		1	Cartesian format
DYNPICOORDS	Controls whether pointer input uses relative or absolute format for coordinates.	0	Relative coordinates
		1	Absolute coordinates

5.3.2. Vertical Dynamic Prompts List

Command Prompts List is now displayed vertically by default in GstarCAD 2024, which allows users to see all the prompts at once, it simplifies drawing operations. Horizontal prompts list could still be activated by using the system variable DYNLISTSTYLE.

You can select the prompts in three ways: Up/Down keys on the keyboard, mouse-clicking and shortcut keys:

- **Up/Down keys:** In addition to expanding and collapsing the prompts list, you can also use Up and Down keys to switch between the prompts.
- **Mouse-clicking:** Simply by moving the mouse cursor to the prompt you want to select to complete the select operation.
- **Shortcut keys:** Each prompt has a corresponding shortcut key which is the capital letter, enter it in the input box to select.

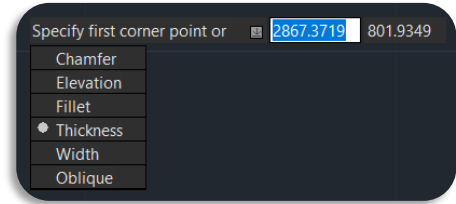

Note: Horizontal prompt list style still exists. You can switch the style using the system variable DYNLISTSTYLE, and restart the software for it to take effect.

System Variable	Description	Value	Value Description
DYNLISTSTYLE	Controls whether the command prompts list is displayed vertically or horizontally	1	Vertically
		2	Horizontally

5.3.3. Dynamic Dimension Input

When creating and editing objects in GstarCAD 2024, data such as length, angle, radius, etc., are displayed in the form of dimensions, which are dynamically changing as the mouse cursor is being moved. With the help of the independent Pointer Input boxes, users are now able to input dimension data and execute design operations more efficiently.

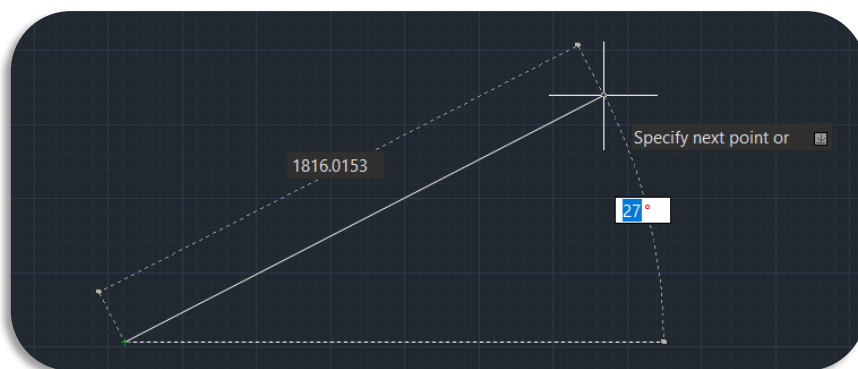

Other than during the drawing process, dynamic dimension input will also be activated during grip editing. Entering the grip editing state, the dimensions of the selected objects will show. You can edit the dimension data when moving the grip, thereby adjusting the objects

Enable Dimension Input where possible: Turns on dimension input and shows dynamic dimension lines in real time.

Note: Dimension input is not available for some commands that prompt for a second point. (DYNMODE system variable)

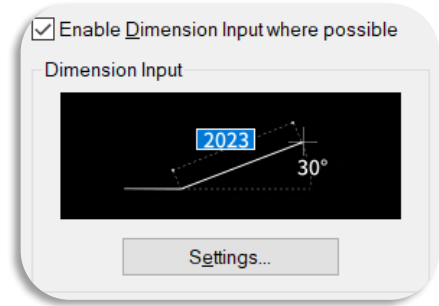

Dimension Input Settings:

Controls the settings of dimension input tooltips. You can modify Dimension Input Settings by going to Drafting Settings (DSETTINGS command) > Dynamic Input > Settings.

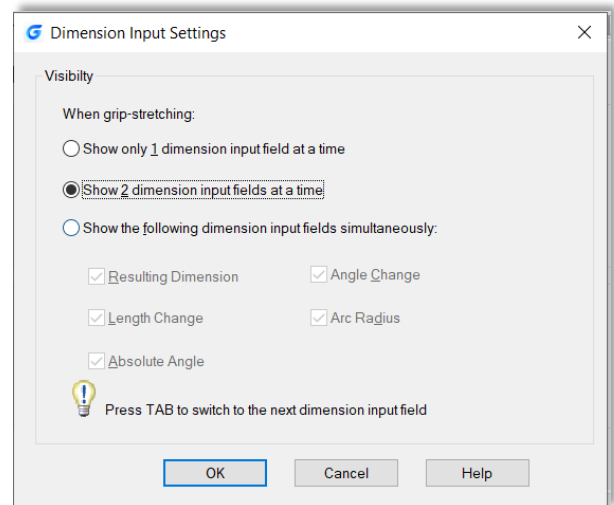

- **Visibility:** Controls which tooltips are displayed during grip stretching when dimension input is on. (DYNDIVIS system variable)
- **Show only 1 dimension input field at a time:** When you are using grip editing to stretch an object, displays only the length change dimension input tooltip (DYNDIVIS system variable)
- **Show 2 dimension input fields at a time:** When you are using grip editing to stretch an object, displays the length change and resulting dimension input tooltips. (DYNDIVIS system variable)
- **Show the following dimension input fields simultaneously:** When you are using grip editing to stretch an object, displays the dimension input tooltips that are selected in the list below. (DYNDIVIS and DYNDIGRIP system variables)
- **Resulting Dimension:** Displays a length dimension tooltip that is updated when moving the grip.
- **Length Change:** Displays the change in length when moving the grip.

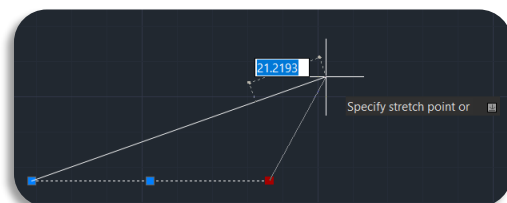
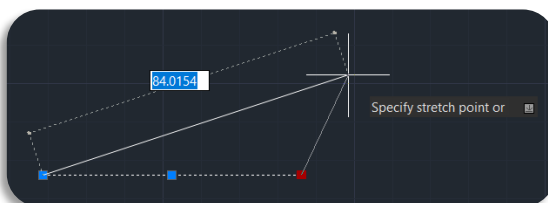

- **Absolute Angle:** Displays an angle dimension tooltip that is updated when moving the grip.
- **Angle Change:** Displays the change in the angle when moving the grip.

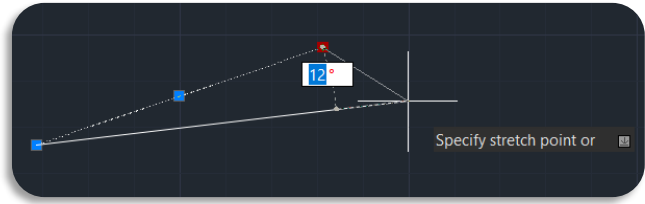
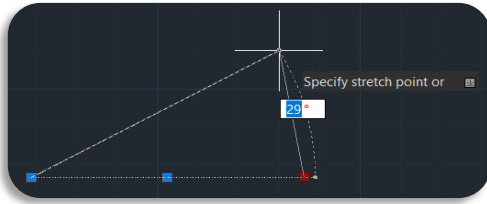

- **Arc Radius:** Displays the radius of an arc, which is updated when moving the grip.

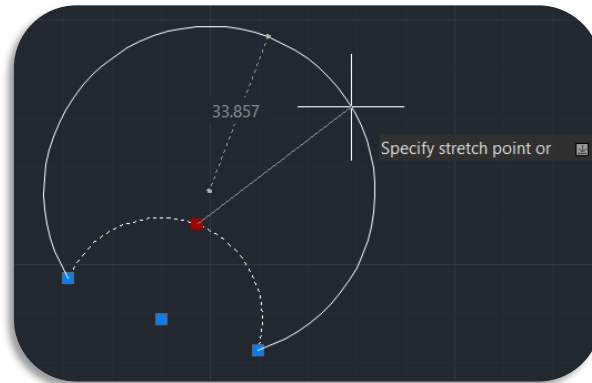

System Variable	Description	Value	Value Description
DYNMODE	Turns Dynamic Input features on and off.	0	All Dynamic Input features off, including dynamic prompts
		1	Pointer input on
		2	Dimension Input on
		3	Pointer Input on and Dimension Input on
DYNDIVIS	Controls whether pointer input uses relative or absolute format for coordinates.	0	Only the first dynamic dimension in the cycle order is displayed
		1	Only the first two dynamic dimensions in the cycle order are displayed
		2	Displays all dynamic dimensions controlled by the DYNDIGRIP system variable.

Dimension Input Style:

You can click the GstarCAD logo(File) ➤ Option (OPTIONS command) ➤ Display ➤ Colors ➤ 2D model space ➤ Dynamic dimension lines, to change the color of the dynamic dimension lines. The default color is RGB (150,156,154).

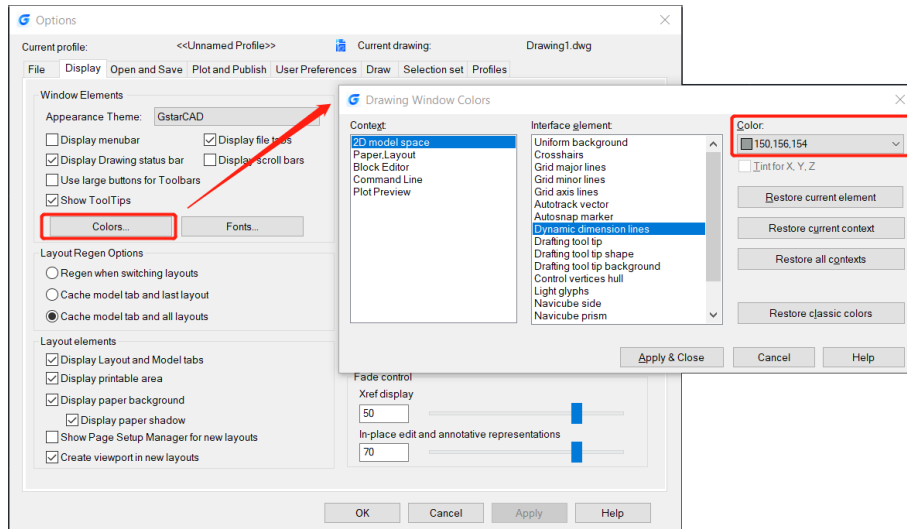

5.4. BIM Support [New](#)

You can enter IFCIMPORT command or click Ribbon ➤ BIM ➤ Open IFC Files to import an IFC file with complete BIM data.

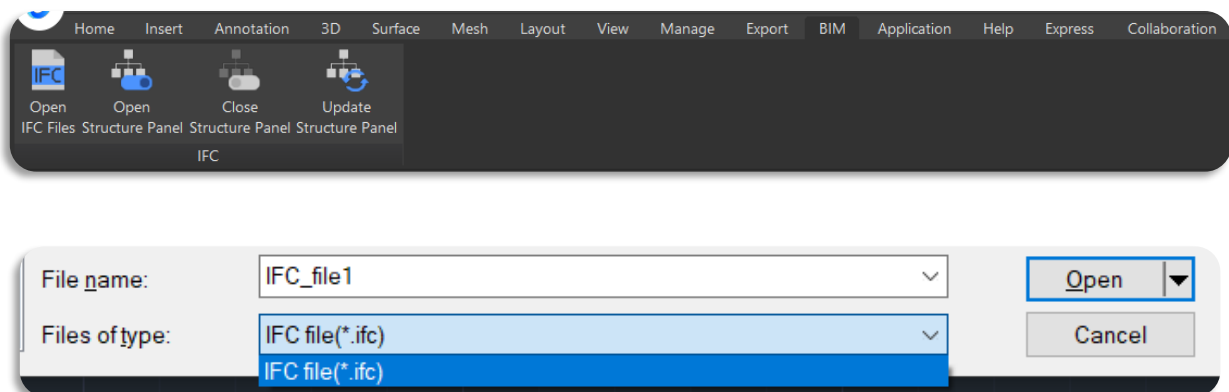

After opening an IFC file, you can select an entity and go to the Properties Panel to its BIM information.

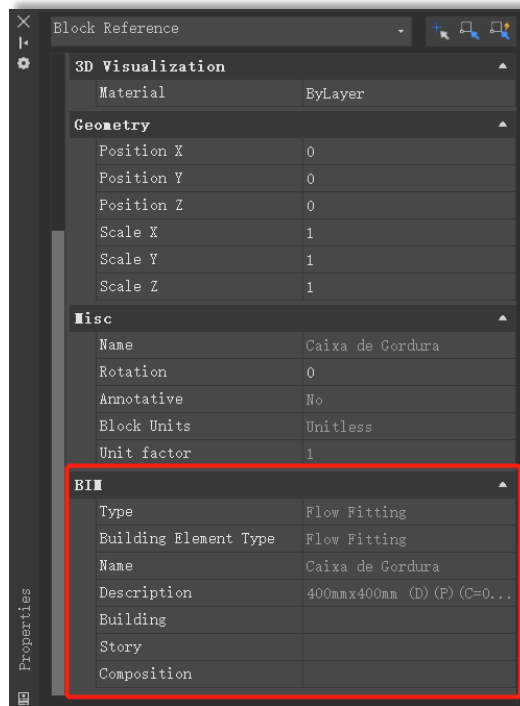

You can also check and manage the entities using Structure Panel, which displays a tree structure of entities based on BIM data.

You can execute operations by clicking buttons on Ribbon ➤ BIM, or entering the following commands.

- **STRUCTUREPANEL:** Open structure panel
- **STRUCTUREPANELCLOSE:** Close structure panel
- **STRUCTUREPANELUPDATE:** Update structure panel

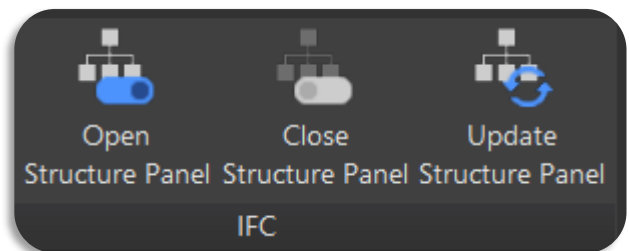

Structure Panel Menu: Displays the Structure Panel main menu.

- **BIM:** Displays a BIM entity-based structure.
- **Configure structure tree:** Opens the Configure Structure Tree dialog box, which allows you to set the structure tree configurations.
- **Select Configuration...:** Allows you to load Structure Tree Configuration Files (*.gst).

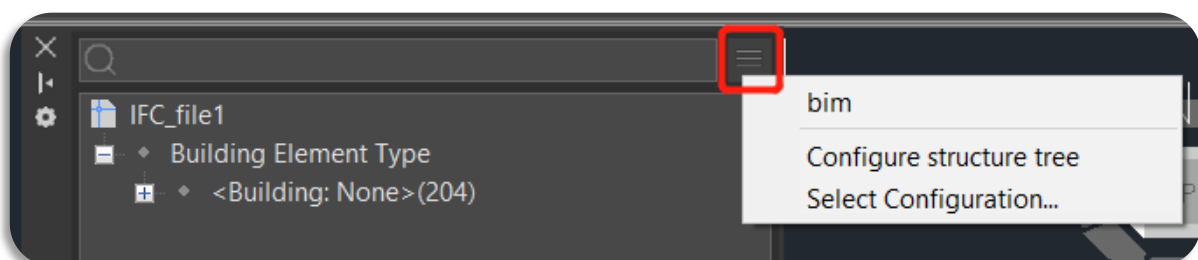

Structure Panel right-click menu: It is used to manage the entities, you could complete operations including show, hide, isolate, zoom, expand all, collapse all and open the configuration panel.

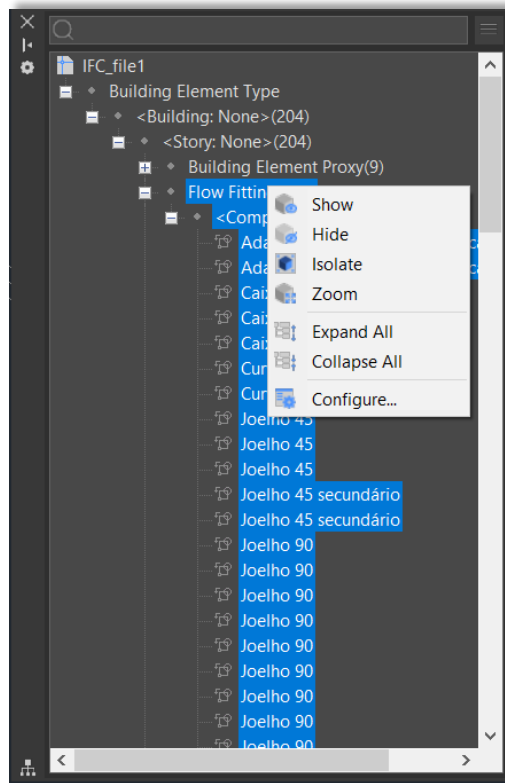

Configure structure tree: Allows users to define the tree structure of the Structural Panel.

- **File:**
 - Open...: select to open another *.gst configuration file.
 - Save: saves the current configuration
 - Save as: saves the current configuration under a different name
- **Group/Sort**
 - Add: Adds a new rule or property
 - Select an existing rule, then click the Add or right-click and select Add Rule in the right-click menu.
 - The new rule will be added below the selected rule.
 - Right-click the new rule and click Rename in the right-click menu and input a new name.

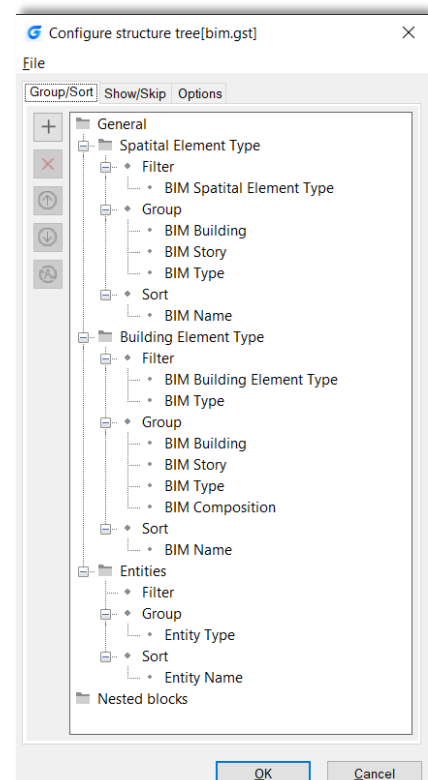

- Select the Filter node of the new rule, then click the Add or right-click and select Add filter property.
 - Select the Group node of the new rule, then click the Add or right-click and select Add Grouping Property.
 - Select the Sort node of the new rule, then click the Add or right-click and select Add sorting property.
 - The Select Property dialog box pops up, select a property, then click.
- Delete: deletes the selected rule or property.
 - Move Up: moves the selected rule or property up.
 - Move Down: moves the selected rule or property down.
 - Toggle negations: filter properties only

➤ **Show/Skip:**

You can pick an option and then select the entity types which you want to follow the option you pick.

➤ **Options:**

- The drop-down list is to select what happens in the model space when entities are selected in the Structure Tree.
- The checkboxes are to select what happens in the structure tree when an entity is selected/deselected in the model space. The following options are checked by default: On entity selection, select in tree; On entity selection, expand parent in tree; Deselect entities on hide.

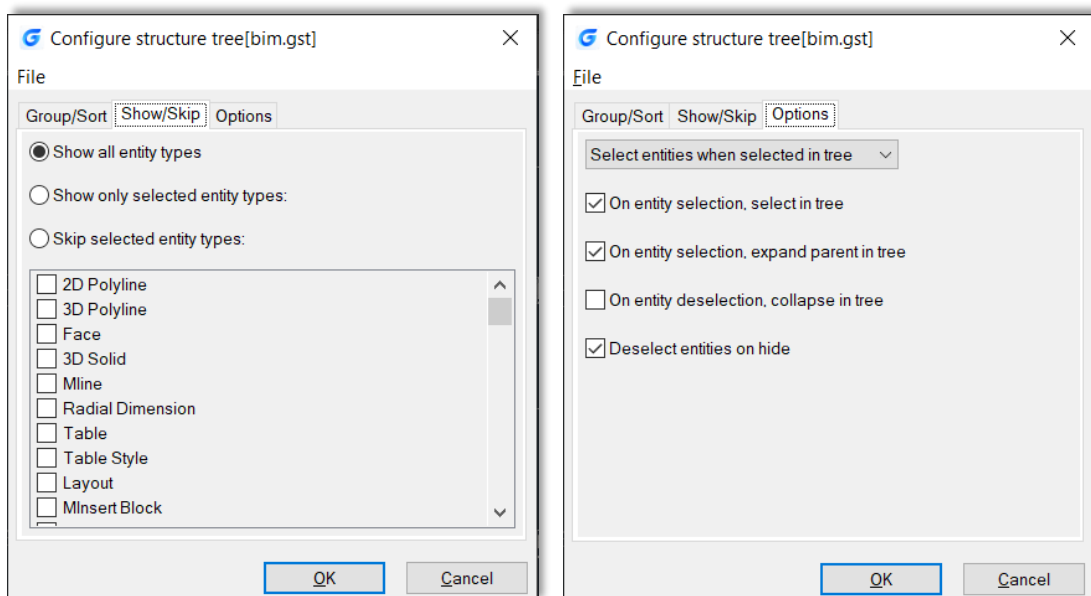

5.5. STEP/IGES Files Import [New](#)

STEP (Standard for the Exchange of Product Model Data) is an international standard established by the International Organization for Standardization (ISO) that defines how product information is represented and exchanged throughout the entire product lifecycle. The file formats include .step, .stp, and .ste.

IGES (The Initial Graphics Exchange Specification) is a general ANSI information exchange standard based on CAD (Computer-Aided Design) and CAM (Computer-Aided Manufacturing) systems. The file formats include .igs or .iges.

GstarCAD 2024 supports the import of STEP/IGES files, enhancing our platform's capability for 3D model data.

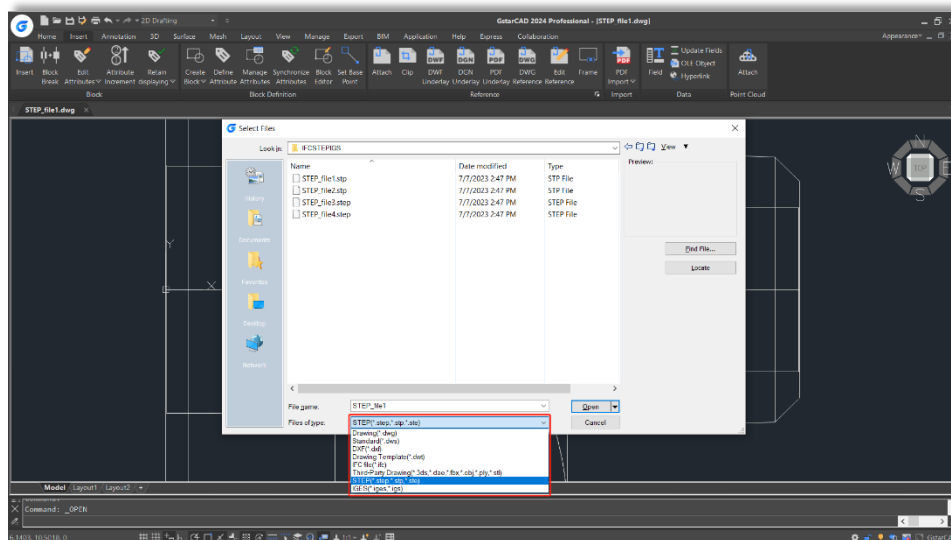

You can go to GstarCAD logo > Open, or GstarCAD logo > Import > Other Formats, and select STEP/IGES in the drop-down list of Files of types to open or import STEP/IGES files. Besides, you could also simply enter STPIMPORT or IGSIMPORT command.

5.6. Viewports Edit [New](#)

You can add, merge and adjust viewports by simply holding and dragging the borderlines of viewports with your mouse cursor.

Single Viewport Adjust: Hover your mouse cursor over a viewport borderline and it will become a two-way arrow " \leftrightarrow ", then you can click and drag the viewport borderline left/right, or up/down to adjust the viewport size.

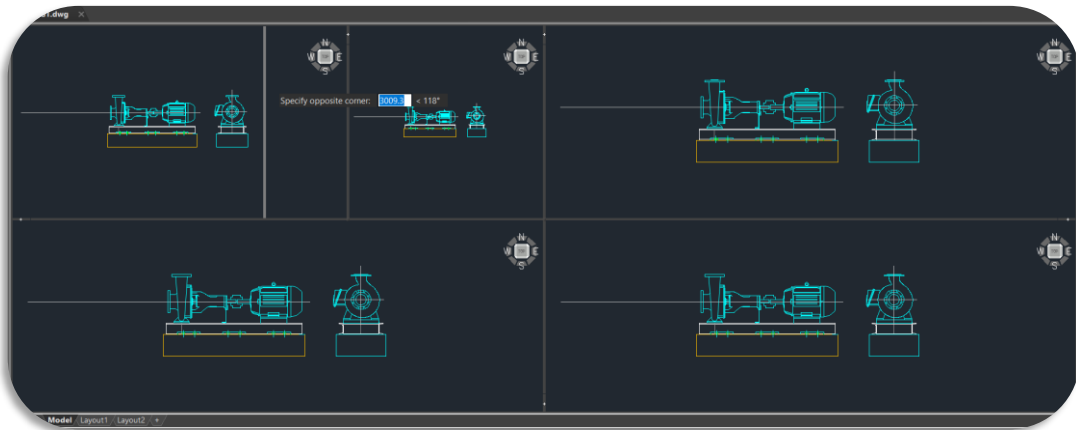

Multiple Viewports Adjust: Hover your mouse cursor over the cross point of viewport borderlines and it will become a cross arrow, then you can click and drag the cross point to adjust multiple viewports size at once.

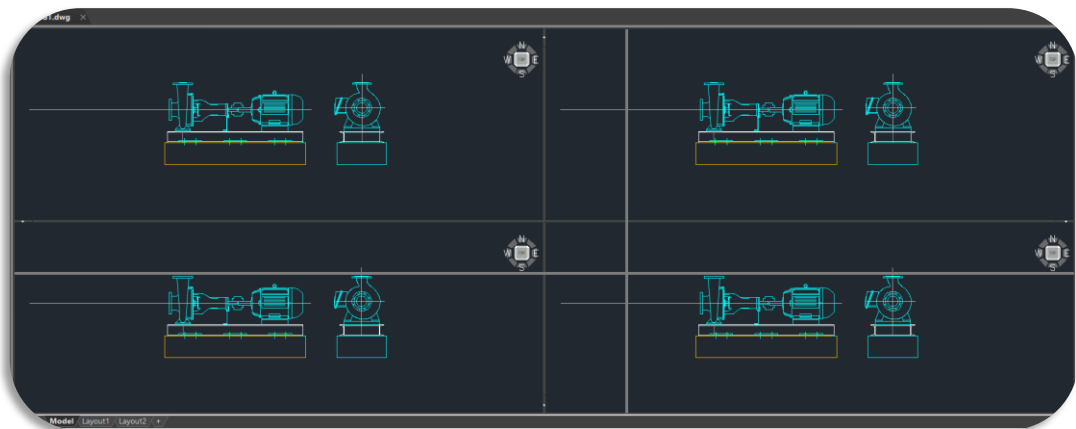

Add: You can hover your mouse cursor on the "+" area of a viewport borderline and it will become a two-way arrow " \leftrightarrow ". Then you can click and drag the viewport borderline left/right or up/down, and the borderline turns into a green dividing line. Release the mouse where you want to divide the viewport and a new viewport will be created. Or you can press the Ctrl key while adjusting the viewport size to add a new viewport.



Merge: Use your mouse cursor to drag one viewport borderline left/right or up/down to where another is, and a white highlight line will appear on the outer border of the two viewports, then release to merge the viewports.

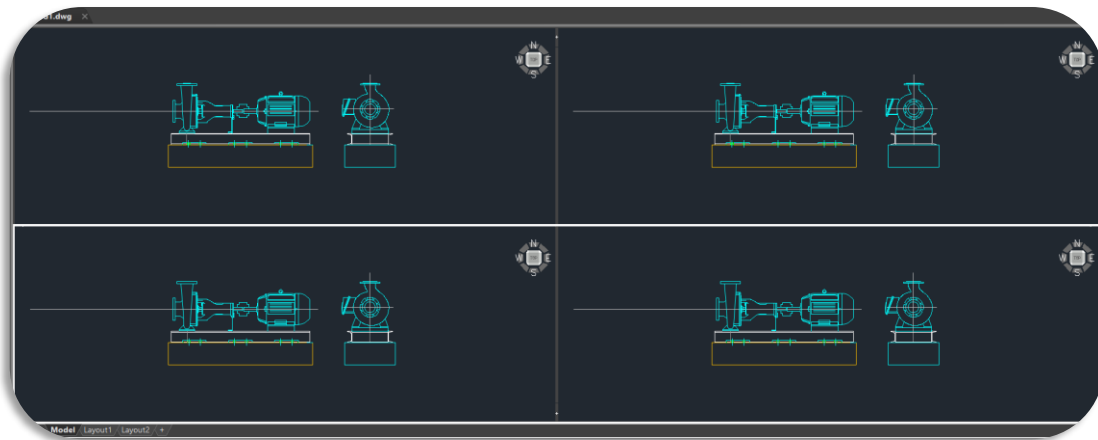

5.7. VPMAX/VPMIN [New](#)

VPMAX allows you to expand the current layout viewports and switch to Model Space for editing without worrying about messing up viewports' scales and limits, while VPMIN allows you to restore the current layout viewport.

System Variable	Description	Value	Value Description
VPMAXIMIZEDSTATE	Controls whether to maximize the current viewport (read-only)	0	Do not maximize
		1	Maximize

5.7.1. VPMAX

Expands the current layout viewports to fill the screen and switches to Model Space for editing.

You can enter the viewport maximized state in the following four ways:

- Enter the VPMAX command in the Layout Space, and then click to select the viewport to be maximized; (when there is only one viewport in the layout, the viewport will be maximized directly without the need to select)
- Enter the VPMAX command after selecting a viewport in the layout space;
- Double-click the viewport border in the Layout Space;

- Click the maximize viewport icon on the status bar in the Layout Space .

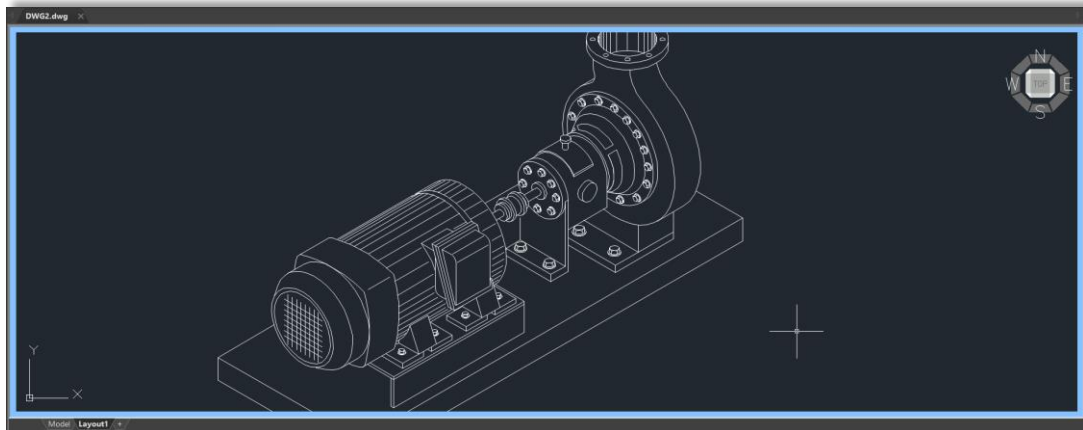

5.7.2. VPMIN

Exits the maximized state and returns to the current Layout Space.

You can exit the viewport maximized state in the following three ways:

- Enter the VPMIN command;
- Double-click the blue border line;
- Click the minimize viewport icon on the status bar in the Layout Space .

5.8. DWFX Batch Digital Signing Tool [New](#)

You can find the application digitalsign.exe in the program installation path to signs DWFX, DWG and DWT files in bulk with digital signatures efficiently.

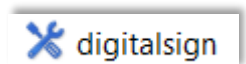

In the Attach Digital Signatures dialog box:

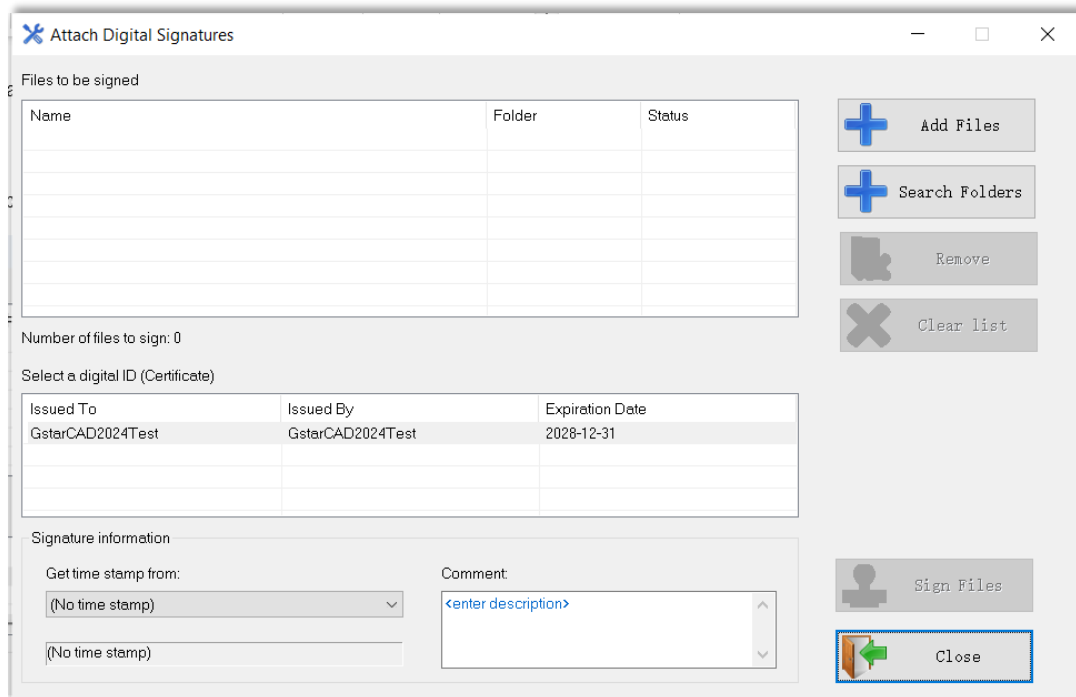

- **Files to be signed:** Displays a list of files added to be signed with their folders and status(empty, signed, previously signatures). The number of files you added will also show at the left-bottom of the list.
- **Add Files:** Pops up the Select File dialog box, and you can select the files you want to attach a digital signature to.
- **Search Folders:** Pops up the Browse for Folder dialog box, you can select the folder of files you want to attach a digital signature to and then click OK.
- **Remove:** Removes the selected files from the list
- **Clear List:** Empties the whole file list
- **Select a Digital ID (Certificate):** Select a digital ID to attach to the files you selected in the Files to Be Signed list.
- **Get Time Stamp From:** Select a time service if you want to add a time stamp to the signed files.
- **Comment:** Add any extra description to the files you are signing.
- **Sign Files:** Starts the signing process, it will pop up a Signing Complete dialog box after finishing and display the Number of files signed.
- **Close:** Close the Attach Digital Signatures dialog box.

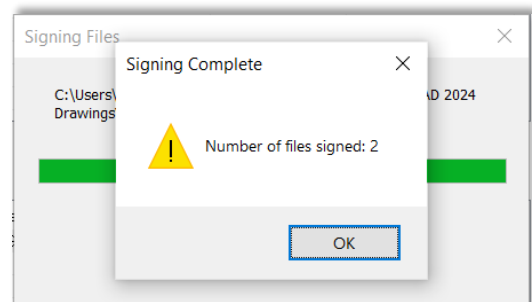

If the file you want to sign is read-only, the Read-only File dialog box will be displayed, you can select according to your needs.

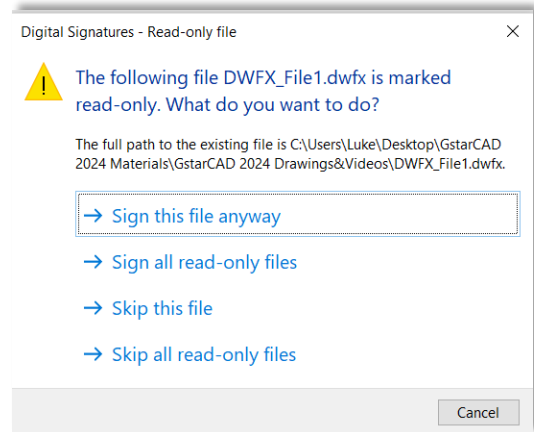

Note: If you choose either a Medium or High-security level when you obtained your digital ID, a message will be displayed each time you try to attach a digital signature to a file.

Right-Click Menu:

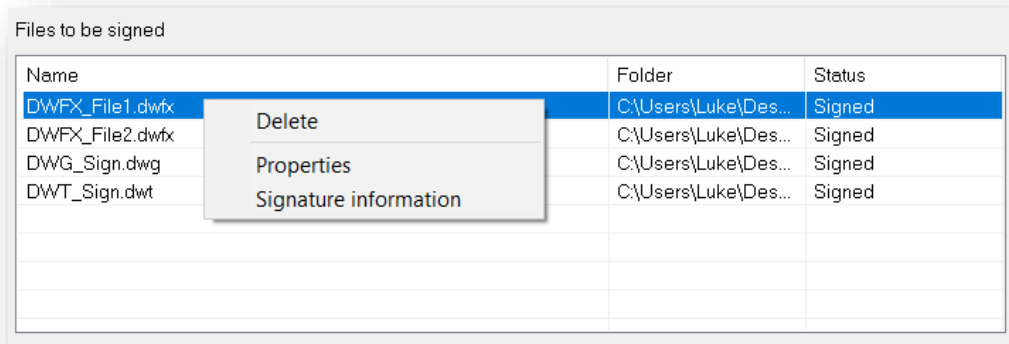

- **Delete:** deletes the selected file
- **Properties:** Pop up the system Properties window
- **Signature information:** Pop up the View the signature details window

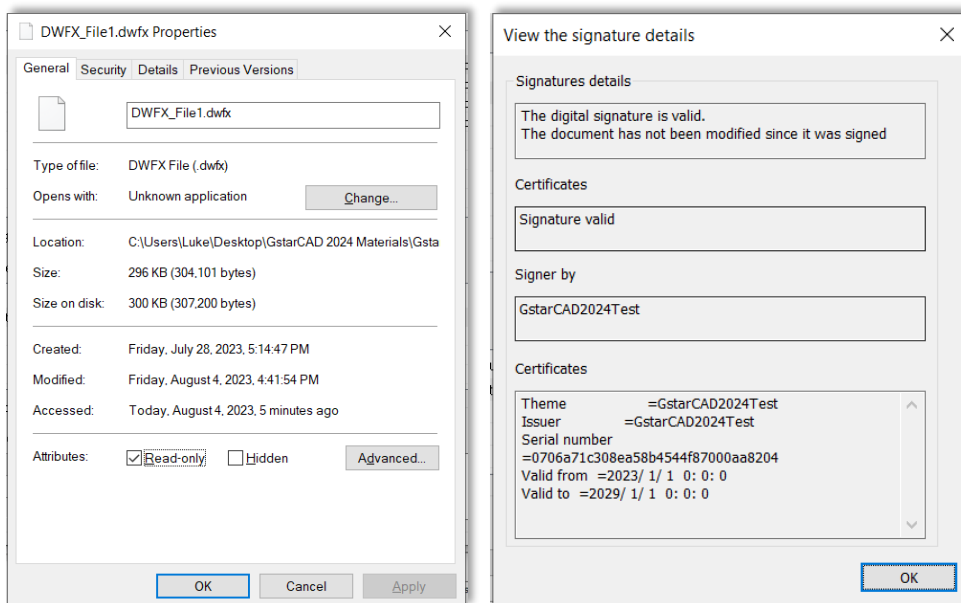



GstarCAD 2024

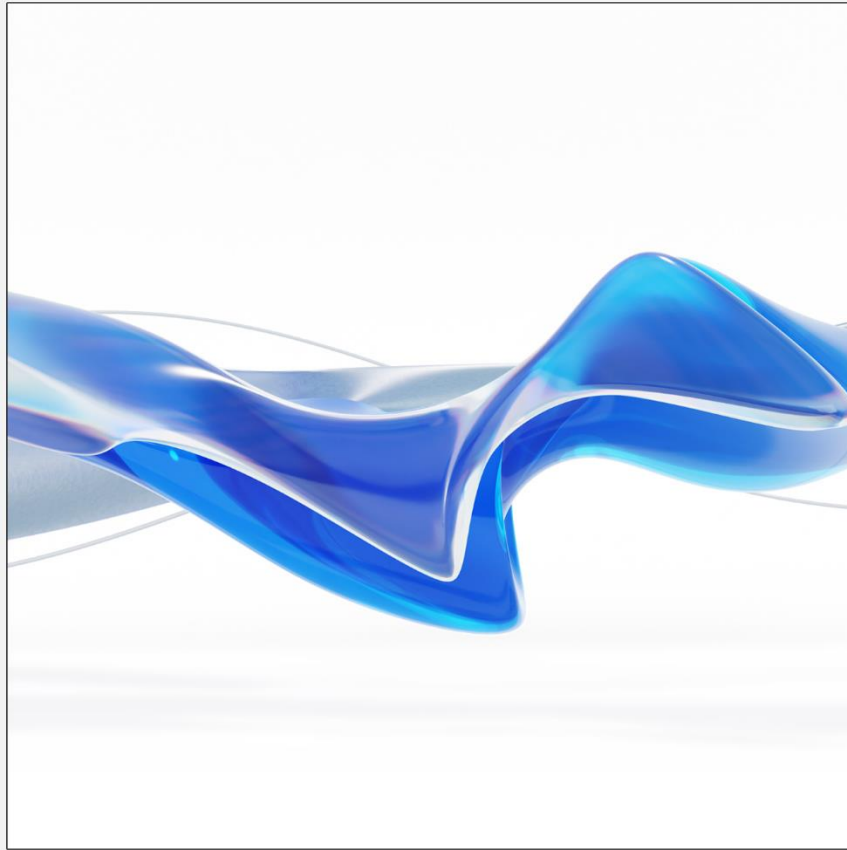

■ <https://www.gstarcad.net/>